

Article number: 23017711110K
 Description: E+G Handwheel
 VR.100 FP-A10-K

Measures

VR.FP-A

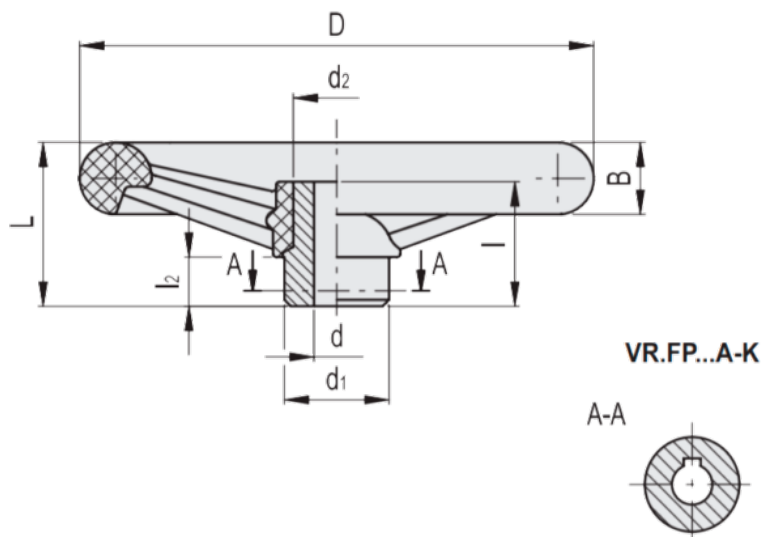

B	= 14	l	= 36
b	= 3	L	= 40
C (N*m)	= 67	L (J)	= 5
D	= 98	l2	= 12
d1	= 24	t	= 11.4
d2	= 20		
d'''	=		
d''''	=		